

Approval body for construction products
and types of construction

Bautechnisches Prüfamt

An institution established by the Federal and
Laender Governments



European Technical Assessment

ETA-18/0242
of 13 November 2020

English translation prepared by DIBt - Original version in German language

General Part

Technical Assessment Body issuing the
European Technical Assessment:

Deutsches Institut für Bautechnik

Trade name of the construction product

fischer concrete screw ULTRACUT FBS II

Product family
to which the construction product belongs

Fasteners for use in concrete for redundant
non-structural systems

Manufacturer

fischerwerke GmbH & Co. KG
Klaus-Fischer-Straße 1
72178 Waldachtal
DEUTSCHLAND

Manufacturing plant

fischerwerke

This European Technical Assessment
contains

16 pages including 3 annexes which form an integral part
of this assessment

This European Technical Assessment is
issued in accordance with Regulation (EU)
No 305/2011, on the basis of

EAD 330747-00-0601, Edition 06/2018

This version replaces

ETA-18/0242 issued on 30 October 2018

European Technical Assessment

ETA-18/0242

English translation prepared by DIBt

Page 2 of 16 | 13 November 2020

The European Technical Assessment is issued by the Technical Assessment Body in its official language. Translations of this European Technical Assessment in other languages shall fully correspond to the original issued document and shall be identified as such.

Communication of this European Technical Assessment, including transmission by electronic means, shall be in full. However, partial reproduction may only be made with the written consent of the issuing Technical Assessment Body. Any partial reproduction shall be identified as such.

This European Technical Assessment may be withdrawn by the issuing Technical Assessment Body, in particular pursuant to information by the Commission in accordance with Article 25(3) of Regulation (EU) No 305/2011.

Specific Part

1 Technical description of the product

The fischer concrete screw ULTRACUT FBS II is an anchor of size 6 mm made of hardened carbon steel. The anchor is screwed into a predrilled cylindrical drill hole. The special thread of the anchor cuts an internal thread into the member while setting. The anchorage is characterised by mechanical interlock in the special thread.

The product description is given in Annex A.

2 Specification of the intended use in accordance with the applicable EAD

The performances given in Section 3 are only valid if the anchor is used in compliance with the specifications and conditions given in Annex B.

The verifications and assessment methods on which this European Technical Assessment is based lead to the assumption of a working life of the anchor of at least 50 years. The indications given on the working life cannot be interpreted as a guarantee given by the producer, but are to be regarded only as a means for choosing the right products in relation to the expected economically reasonable working life of the works.

3 Performance of the product and references to the methods used for its assessment

3.1 Safety in case of fire (BWR 2)

Essential characteristic	Performance
Reaction to fire	Class A1
Resistance to fire	See Annex C 3

3.2 Safety in use (BWR 4)

Essential characteristic	Performance
Characteristic resistance to tension load (static and quasi-static loading)	See Annex B 4, Annex C 1 and C 2
Characteristic resistance to shear load (static and quasi-static loading)	See Annex C 1 and C 2
Durability	See Annex B 1

4 Assessment and verification of constancy of performance (AVCP) system applied, with reference to its legal base

In accordance with European Assessment Document EAD No. 330747-00-0601, the applicable European legal act is: [97/161/EC].

The system to be applied is: 2+

5 Technical details necessary for the implementation of the AVCP system, as provided for in the applicable European Assessment Document

Technical details necessary for the implementation of the AVCP system are laid down in the control plan deposited at Deutsches Institut für Bautechnik.

Issued in Berlin on 13 November 2020 by Deutsches Institut für Bautechnik

Dipl.-Ing. Beatrix Wittstock
Head of Section

beglaubigt:
Tempel

Product in the installed condition

Installed condition in normal weight concrete

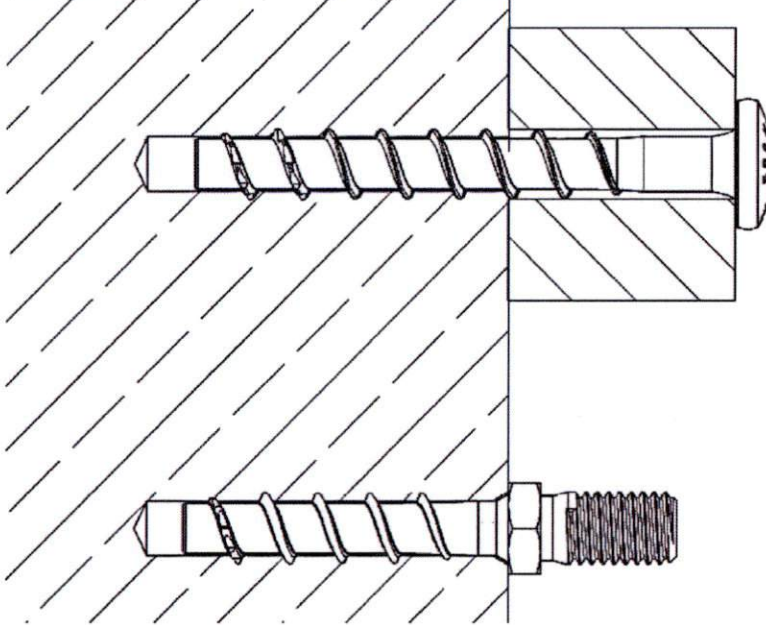

Installed condition in
prestressed hollow core slabs

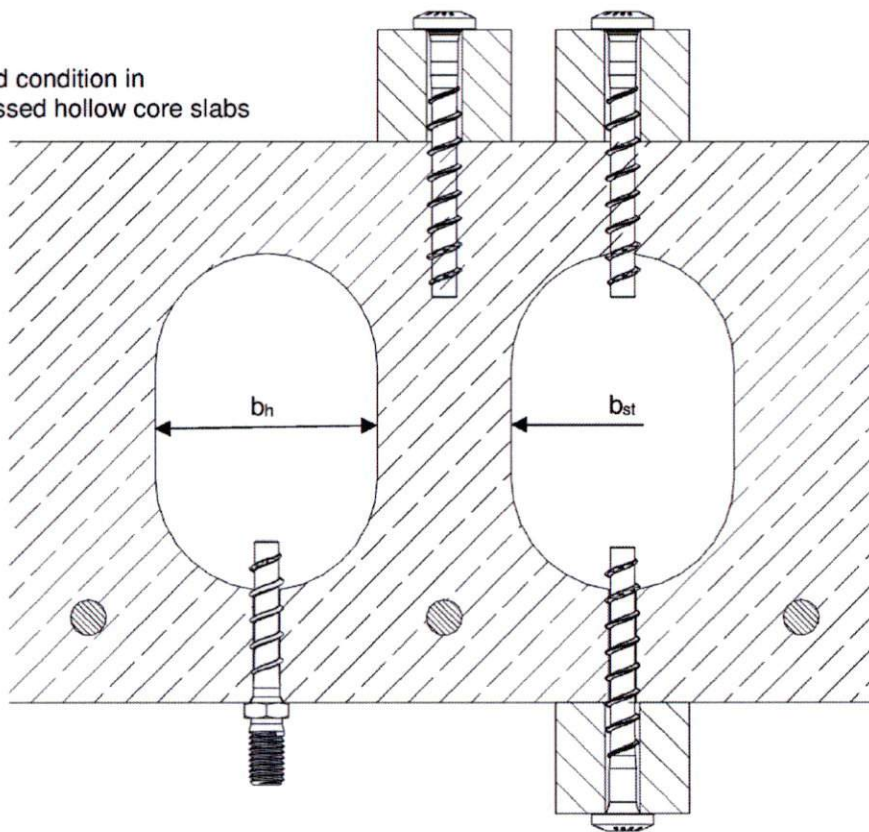



(Figure not to scale)

fischer concrete screw ULTRACUT FBS II

Product description
Product in the installed condition

Annex A 1

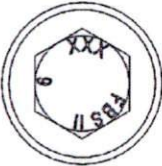
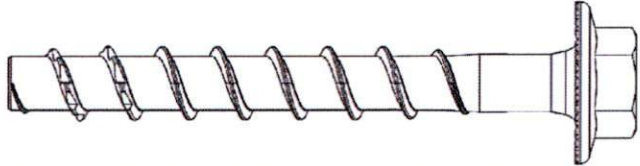
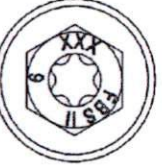
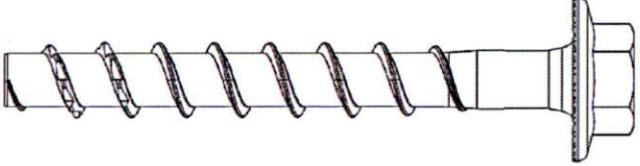
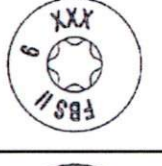
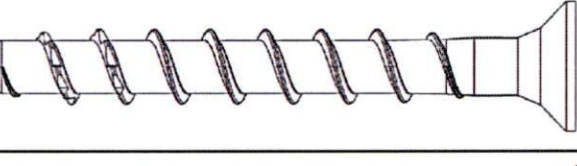
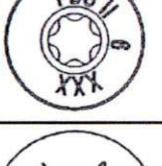
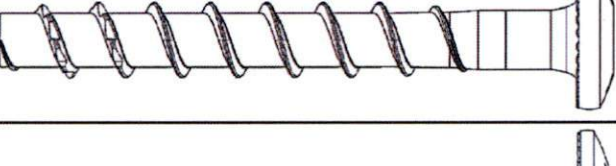
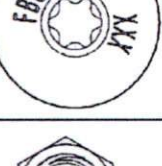
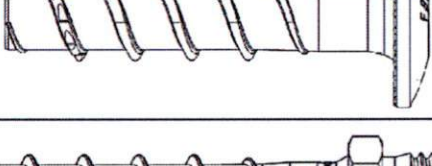
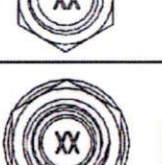
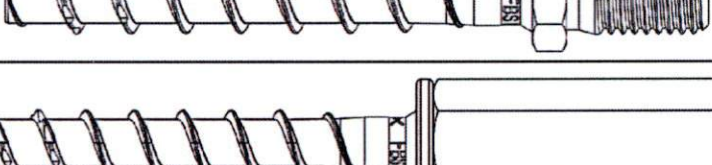
Table A2.1: Screw types FBS II 6

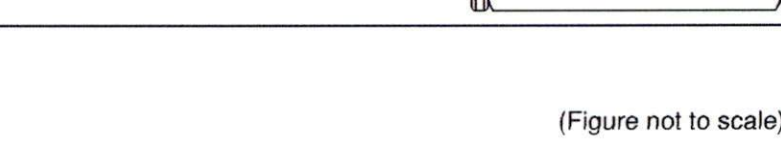
FBS II 6		
Hexagon head with formed washer (US)		
Hexagon head with formed washer and TX-drive (US TX)		
Countersunk head (SK)		
Pan head (P)		
Large pan head (LP)		
Hexagon head and connection thread M8 or M10 (M)		
Hexagon connecting nut with metric internal thread (I)		

(Figure not to scale)

fischer concrete screw ULTRACUT FBS II

Product description
Screw types FBS II 6

Annex A 2

Table A3.1: Geometry and material

FBS II 6		All head shapes	
Thread outer diameter	d_a	[mm]	7,75
Core diameter	d_k		5,65
Shaft diameter	d_s		6,0
Material	[-]	Hardened carbon steel; $A_5 \geq 8\%$	
Coating		galvanized	

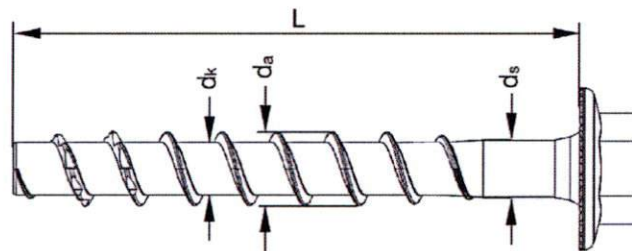

Head marking at US, US TX, SK, P, LP

FBS II: Product identification

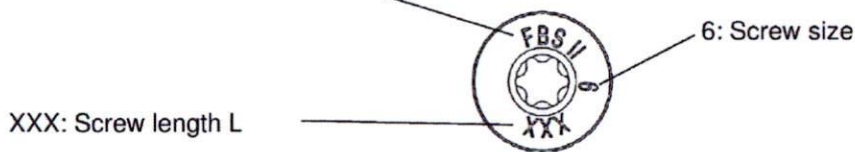

Marking at M8, M10, I

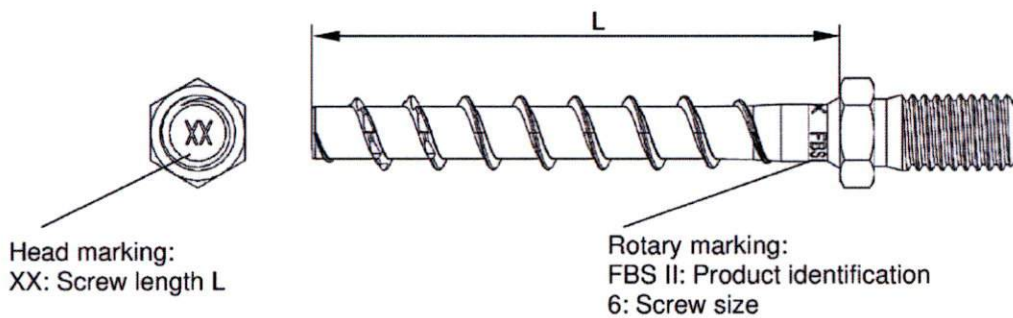

(Figure not to scale)

fischer concrete screw ULTRACUT FBS II

Product description
Geometry, material and marking

Annex A 3

Specification of intended use:

Anchorage subject to:

- Static and quasi static loads: all types and embedment depths
- Used in concrete for redundant non-structural systems
- Used for fire: only for concrete C20/25 to C50/60 (does not apply for prestressed hollow core slabs)

Base materials:

- Compacted reinforced and unreinforced normal weight concrete without fibres (cracked and uncracked) according to EN 206:2013+A1:2016
- Strength classes C20/25 to C50/60 according to EN 206:2013+A1:2016
- Prestressed hollow core slabs, where the cavity width does not exceed 4.2 times the web width ($b_H \leq 4,2 \times b_{St}$) with strength classes C30/37 to C50/60

Use conditions (Environmental conditions):

- Structures subjected to dry internal conditions

Design:

- Anchorages are to be designed under the responsibility of an engineer experienced in anchorages and concrete work
- Verifiable calculation notes and drawings are to be prepared taking account of the loads to be anchored. The position of the screw is indicated on the design drawings (e.g. position of the screw relative to reinforcement or to supports, etc.)
- Design of fastenings according to EN 1992-4: 2018 and EOTA Technical Report TR 055

Installation:

- Hammer drilling or hollow drilling
- Screw installation carried out by appropriately qualified personnel and under the supervision of the person responsible for technical matters on site
- In case of aborted hole: New hole must be drilled at a minimum distance of twice the depth of the aborted hole or closer, if the hole is filled with a high strength mortar and only if the hole is not in the direction of the oblique tensile or shear load
- Adjustability according to Annex B3 and B6
- Cleaning of drill hole is not necessary when using a hollow drill or:
 - If drilling vertically upwards
 - If drilling vertically downwards and the drill hole depth has been increased. It is recommended to increase the drill depth with additional $3 d_0$
- After correct installation further turning of the screw head shall not be possible
- The head of the screw must be fully engaged on the fixture and show no signs of damage
- In Precast pre-stressed hollow core slabs the screw may be installed from all directions, if the web thickness and the spacing to the tensioning strands according to table B3.1 are observed (also in the area of solid material)

fischer concrete screw ULTRACUT FBS II

Intended use
Specification

Annex B 1

Table B2.1: Installation parameters – drilling bore hole and setting tools

FBS II 6		All head shapes	
Nominal embedment depth	h_{nom}	$25 \leq h_{nom} < 35$	$35 \leq h_{nom} \leq 55$
Nominal drill hole diameter	d_o	6	
Cutting diameter of drill bits	$d_{cut} \leq$	6,4	
Clearance hole diameter	$d_f \leq$	8	
Drill hole depth		$h_{nom} + 5$	$h_{nom} + 10^{1)}$
Drill hole depth (with adjustable setting)	$h_1 \geq$	$h_{nom} + 15$	$h_{nom} + 20$
Torque impact screw driver	$T_{imp,max}$	80	450
Maximum installation torque with metrical screws or hexagon nuts on head shapes M and I	T_{max}	5	10

¹⁾ Value can be reduced to $h_{nom} + 5$ for installation vertically upwards

Table B2.2: Installation parameters – drive and fixture

FBS II 6			US	US TX	SK	P	LP	M8	M10	I
Wrench size	SW	[mm]	10 / 13		-			10	13	-
TX size	TX	[-]	-	30						
Head diameter	d_h		17	13,5	14,4	17,5	-			
Thickness of fixture	$t_{fix} \leq$		$L - h_{nom}$							
Length of screw	$L_{min} =$		25							
	$L_{max} =$		325							55

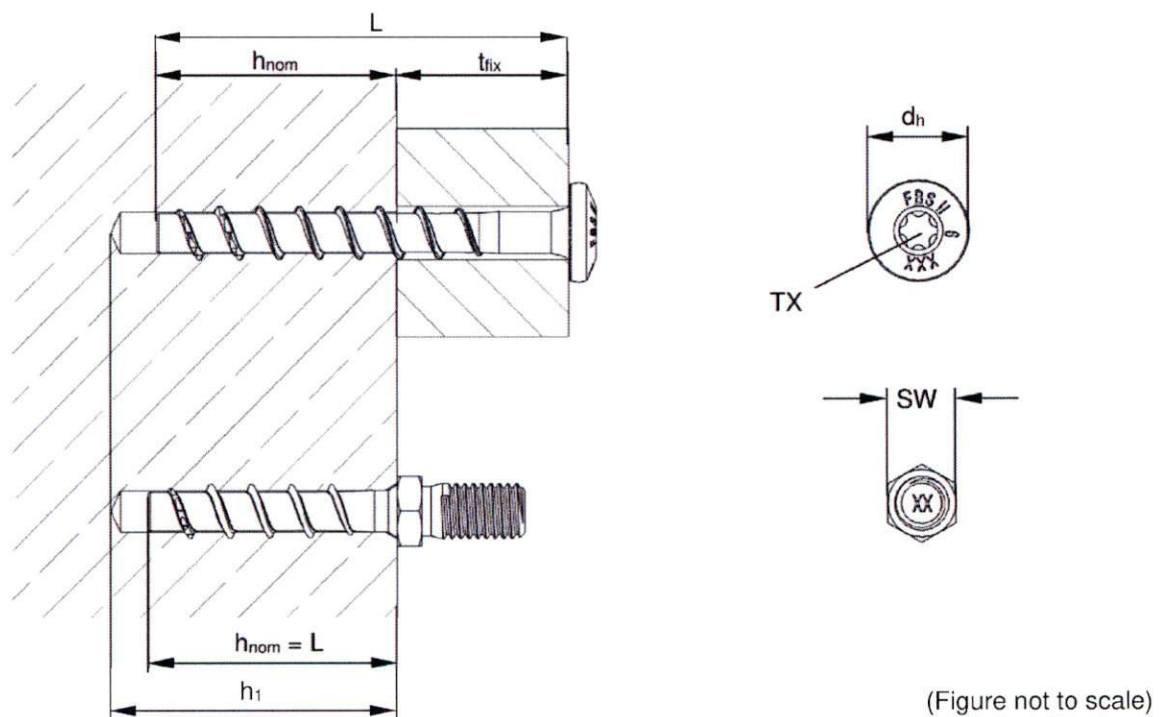

fischer concrete screw ULTRACUT FBS II

Intended use
Installation parameters

Annex B 2

Table B3.1: Installation parameters – Additional information for prestressed hollow core slabs

FBS II 6			
Distance to the tensioning strands	$a_P \geq$	[mm]	50
Thickness of the slab web	$d_b \geq$	[mm]	25
Minimum thickness of fixture	$t_{fix} \geq$		$L - d_b^{1)}$ - 30 mm
Torque impact screw driver	$T_{imp,max}$	[Nm]	80 (450 ²⁾)

- 1) If d_b is not known, then set $d_b = 25$ mm
 2) Parent value applies if all the following conditions are met:
 - $d_b \geq 35$ mm
 - $h_{nom} \geq 35$ mm

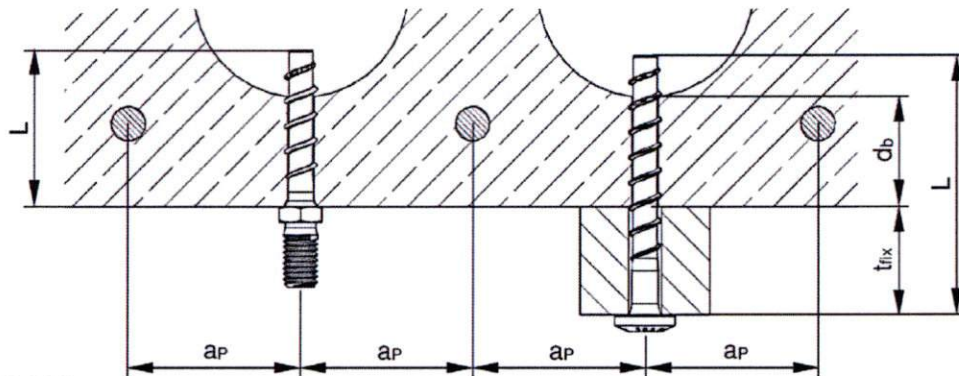

Adjustment

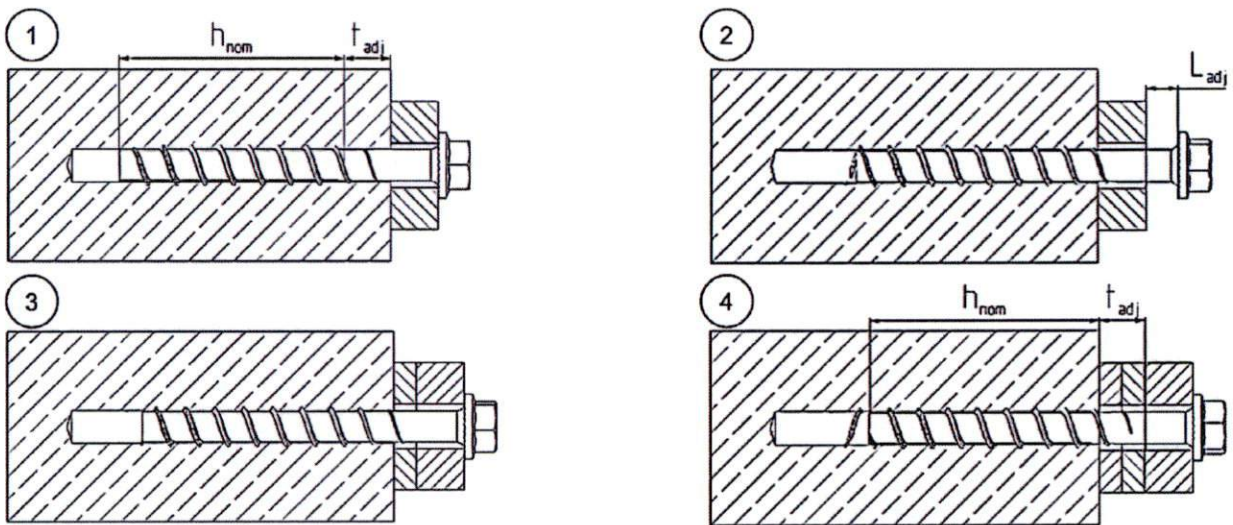

(Figure not to scale)

It is permissible to untighten the screw up to two times for adjustment purposes. Therefore the screw may be untightened to a maximum of $L_{adj} = 20$ mm to the surface of the initial fixture. The total permissible thickness of shims added during the adjustment process is $t_{adj} = 10$ mm.

fischer concrete screw ULTRACUT FBS II	Annex B 3
Intended use Installation parameters prestressed hollow core slabs and adjustment	

Table B4.1: Minimum thickness of concrete members, minimum spacing and edge distance

FBS II 6			
Minimum thickness of concrete member	h_{min}	[mm]	$\max.(80; h_1^{1}) + 30$
Minimum spacing	s_{min}		35
Minimum edge distance	c_{min}		

1) Drill hole depth according to table B2.1

Table B4.2: Minimum spacing and edge distance for prestressed hollow core slabs



FBS II 6			
Minimum spacing	s_{min}	[mm]	100
Minimum edge distance	c_{min}		
Minimum distance between anchor groups	a_{min}		

fischer concrete screw ULTRACUT FBS II

Intended use

Minimum thickness of members, minimum spacing and edge distance

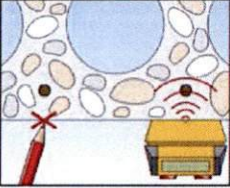
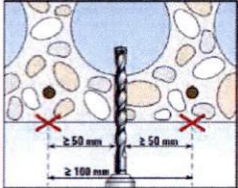
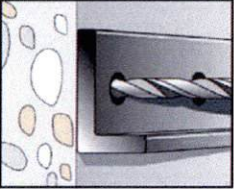
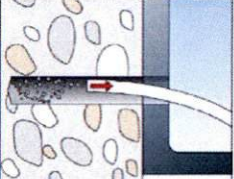
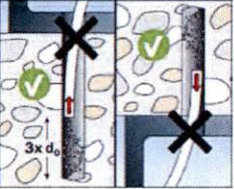
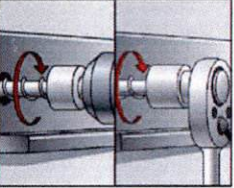
Annex B 4

Installation instruction part 1		
<p>1. </p>	<p>2. </p>	<p>For installation in prestressed hollow core slabs:</p> <p>Determine and mark the position of the tensoring strands, e.g. with a suitable scanner. Keep distances to the tensoring strands according to table B3.1.</p>
		<p>Step 1: Creation of the drill hole:</p> <p>Drill the hole using hammer drill or hollow drill</p> <p>Drill hole diameter d_0 and drill hole depth h_1 according to table B2.1</p>
		<p>Step 2: Cleaning of the drill hole - horizontal:</p> <p>Clean the drill hole. This step can be omitted in the preparation of the hole by using a hollow drill bit.</p>
		<p>Step 2: Cleaning of the drill hole - vertical:</p> <p>Cleaning of the drill hole can be omitted, if drilling vertically upwards or if drilling vertically downwards and the hole depth has been increased. It is recommended to increase the drill hole depth by an additional 3 x drilling \varnothing when drilling vertically downwards.</p>
		<p>Step 3: Installation:</p> <p>Installation with any torque impact screw driver up to the maximum mentioned torque moment ($T_{imp,max}$ according to table B2.1). (recommendation: use the fischer FSS 18V 400BL)</p> <p>Alternatively, all other tools without an indicated torque moment are allowed (e.g. ratchet spanner). The indicated torque moments $T_{imp,max}$ for impact screw driver are not decisive for manual installation.</p>
		<p>Step 4: Checking of the correct installation:</p> <p>After installation a further turning of the screw must not be possible. The head of the screw must be in contact with the fixture and is not damaged.</p>
<p>fischer concrete screw ULTRACUT FBS II</p>		
<p>Intended use Installation instruction</p>		<p>Annex B 5</p>

Installation instruction part 2

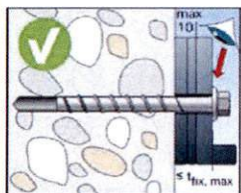
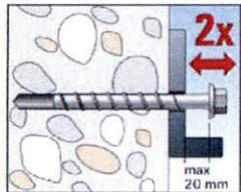
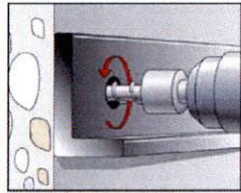

Adjustment

Optional:

It is permissible to adjust the screw twice. Therefore, the screw may be untightened to a maximum of $L_{adj} = 20$ mm off the surface of the initial fixture. The total permissible thickness of shims added during the adjustment process is $t_{adj} = 10$ mm.

fischer concrete screw ULTRACUT FBS II

Intended use
Installation instruction

Annex B 6

Table C1.1: Characteristic values for static and quasi-static action

FBS II 6										
Nominal embedment depth	h_{nom}	[mm]	25	30	35	40	45	50	55	
Steel failure for tension load and shear load										
Characteristic resistance	$N_{Rk,s}$	[kN]	21							
Partial factor	$\gamma_{Ms,N}$	[-]	1,4							
Characteristic resistance	$V^0_{Rk,s}$	[kN]	4,8		9,0			13,3		
Partial factor	$\gamma_{Ms,V}$	[-]	1,5							
Factor for ductility	k_7	[-]	1,0							
Characteristic bending resistance	$M^0_{Rk,s}$	[Nm]	17,1							
Pullout failure										
Characteristic resistance in concrete C20/25	uncracked	$N_{Rk,p}$	[kN]	3,0	5,0	6,5	8,0	10,0	12,0	13,5
	cracked		[kN]	1,5	2,5	3,5	5,0	6,0	7,5	8,5
Increasing factors concrete	C25/30	ψ_c	[-]	1,12						
	C30/37			1,22						
	C35/45			1,32						
	C40/50			1,41						
	C45/55			1,50						
	C50/60			1,58						
Installation factor	γ_{inst}		1,0							
Concrete cone failure and splitting failure; concrete pryout failure										
Effective embedment depth	h_{ef}	[mm]	19	23	27	32	36	40	44	
Factor for uncracked concrete	$k_{ucr,N}$	[-]	11,0							
Factor for cracked concrete	$k_{cr,N}$		7,7							
Characteristic edge distance	$C_{cr,N}$	[mm]	1,5 h_{ef}							
Characteristic spacing	$S_{cr,N}$		3 h_{ef}							
Characteristic resistance for splitting	$N^0_{Rk,sp}$	[kN]	min ($N^0_{Rk,c}{}^1$; $N_{Rk,p}$)							
Characteristic edge distance for splitting	$C_{cr,sp}$	[mm]	2 x h_{ef}			1,5 x h_{ef}				
Characteristic spacing for splitting	$S_{cr,sp}$		4 x h_{ef}			3 x h_{ef}				
Factor for pryout failure	k_8	[-]	1,3			2,0				
Installation factor	γ_{inst}		1,0							
Concrete edge failure										
Effective length in concrete	l_f	[mm]	25	30	35	40	45	50	55	
Nominal diameter of screw	d_{nom}		6							
Adjustment										
Maximum thickness of shims	t_{adj}	[mm]	10							
Max. number of adjustments	n_a	[-]	2							
1) $N^0_{Rk,c}$ according EN 1992-4:2018										
fischer concrete screw ULTRACUT FBS II									Annex C 1	
Performances Characteristic values for static and quasi-static action										

Table C2.1: Characteristic values for static and quasi-static action in prestressed hollow core slabs

FBS II 6																			
Nominal embedment depth		h_{nom}	[mm]	25	30	35	40	45	50	55									
All load directions and failure modes																			
Characteristic resistance	C30/37	$d_b \geq 25$	[kN]	0,5	1,0														
		$d_b \geq 30$			3,5														
		$d_b \geq 35$			3,5	4,0	4,5	5,0	5,5	6,0	6,5								
		$d_b \geq 40$				4,8	5,5	6,0	7,0	7,5	8,0								
		$d_b \geq 50$			7,0		8,0	9,0		12,0									
	C35/45	$d_b \geq 25$			[kN]	0,6	1,1												
		$d_b \geq 30$					3,8												
		$d_b \geq 35$					3,8	4,3	4,9	5,4	5,9	6,5	7,0						
		$d_b \geq 40$						4,8	5,9	6,5	7,6	8,1	8,6						
		$d_b \geq 50$					7,6		8,6	9,0		13,0							
	C40/50	$d_b \geq 25$					[kN]	0,6	1,1										
		$d_b \geq 30$							4,0										
		$d_b \geq 35$							4,0	4,6	5,2	5,7	6,3	6,9	7,5				
		$d_b \geq 40$								4,8	6,3	6,9	8,0	8,6	9,2				
		$d_b \geq 50$							8,0		9,0		13,3						
	C45/55	$d_b \geq 25$							[kN]	0,6	1,2								
		$d_b \geq 30$									4,3								
		$d_b \geq 35$									4,3	4,8	5,5	6,1	6,7	7,3	7,9		
		$d_b \geq 40$											6,7	7,3	8,5	9,0	9,8		
		$d_b \geq 50$									8,5	9,0		13,3					
	C50/60	$d_b \geq 25$									[kN]	0,6	1,3						
		$d_b \geq 30$											4,5						
		$d_b \geq 35$											4,5	4,8	5,8	6,4	7,1	7,7	8,4
		$d_b \geq 40$													7,1	7,7	9,0		10,3
$d_b \geq 50$		9,0		13,3															
Partial factor	γ_M	[-]	1,5																
Installation factor	γ_{inst}	[-]	1,0																
Characteristic bending resistance	$M^0_{Rk,s}$	[Nm]	17,1																
Partial factor	γ_{Ms}	[-]	1,5																
Edge distance	$C_{cr} = C_{min}$	[mm]	100																
Spacing	$S_{cr} = S_{min}$	[mm]	100																
fischer concrete screw ULTRACUT FBS II																			
Performances Characteristic values in prestressed hollow core slabs																			
Annex C 2																			

Table C3.1: Characteristic values for resistance to fire ^{1) 2)}										
FBS II 6										
Nominal embedment depth	h_{nom}	[mm]	25	30	35	40	45	50	55	
Steel failure for tension load and shear load										
Characteristic resistance for all head shapes	$N_{Rk,s,fi}$	R30	[kN]	1,00						
		R60		0,60						
		R90		0,50						
		R120		0,40						
	$V_{Rk,s,fi}$	R30	[kN]	1,00						
		R60		0,60						
		R90		0,50						
		R120		0,40						
Characteristic bending resistance for all head shapes	$M^0_{Rk,s,fi}$	R30	[Nm]	0,80						
		R60		0,50						
		R90		0,40						
		R120		0,35						
Pullout failure										
Characteristic resistance	$N_{Rk,p,fi}$	R30	[kN]	0,4	0,6	0,9	1,2	1,5	1,9	2,1
		R60								
		R90								
		R120								
Edge distance										
R30 to R120	$C_{cr,fi}$	[mm]	2 h_{ef}							
In case of fire attack from more than one side, the minimum edge distance shall be ≥ 300 mm										
Spacing										
R30 to R120	$S_{cr,fi}$	[mm]	2 $C_{cr,fi}$							
¹⁾ The embedment depth has to be increased for wet concrete by at least 30 mm compared to the given value. ²⁾ Not valid for prestressed hollow core slabs										
fischer concrete screw ULTRACUT FBS II									Annex C 3	
Performances Characteristic values for resistance to fire										